

SUSPENSION MAXX

ADVANCED LEVELING SYSTEMS

INSTALLATION INSTRUCTIONS

MAXX LOAD CELL

#SMX - 2535

INSTALL TIME: 1 HR.







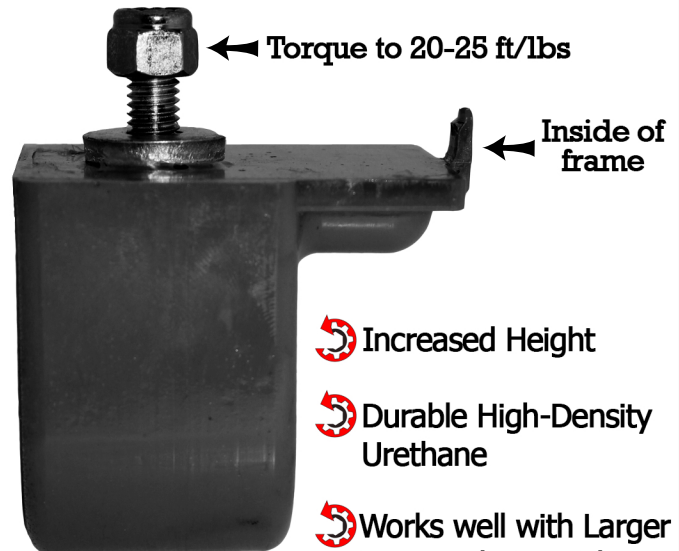
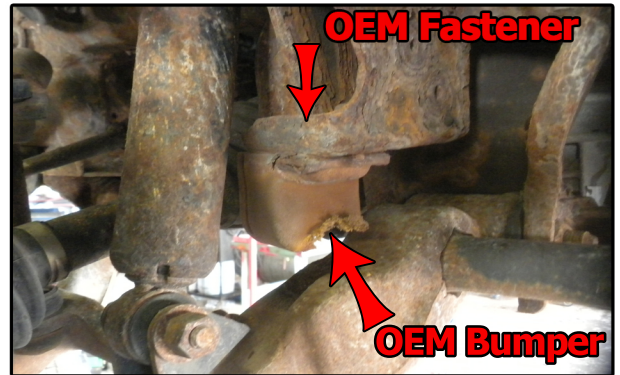

For use with:
 '99-'10 8-Bolt Silverado/Sierra 1500HD, 2500, 2500HD, 3500, 3500HD
 '01-'10 Silverado/Sierra 2WD 2500HD, 3500HD
 '01-'10 Suburban/Yukon XL 2500
 '02-'05 Avalanche 2500
 '03-'09 Hummer H2

1. Raise and Support the vehicle with suitable jack-stands.
2. Locate OEM bump-stop fastener nut.
3. Remove fastener nut with 15mm wrench.
4. Remove Original Foam Bumper.
5. Insert **MAXX** Load Cell, aligning anti-rotation tab inside of frame.
6. Install heavy flat washer and lock-nut.
7. Tighten to 20-25 ft/lbs.

* Apply steps 2-7 to left and right side.



-  Increased Height
-  Durable High-Density Urethane
-  Works well with Larger Tires and Snow Plows
-  Heavy-Duty Fasteners
-  Stainless Load-Plate Resists Corrosion
-  100% American Made

Questions? E-mail us at tech@SuspensionMAXX.com
 Or call 1.888.MAXX.CAM. Visit us on the web at SuspensionMAXX.com



Again, thank you for your purchase! Enjoy your SuspensionMAXX leveling system!