

Heavy-Duty Cast Aluminum Deep Transmission Pan

2020-2025 Ford Super Duty 7.3L Gas

(328053400, 328053410, 328053420)

Installation Guide

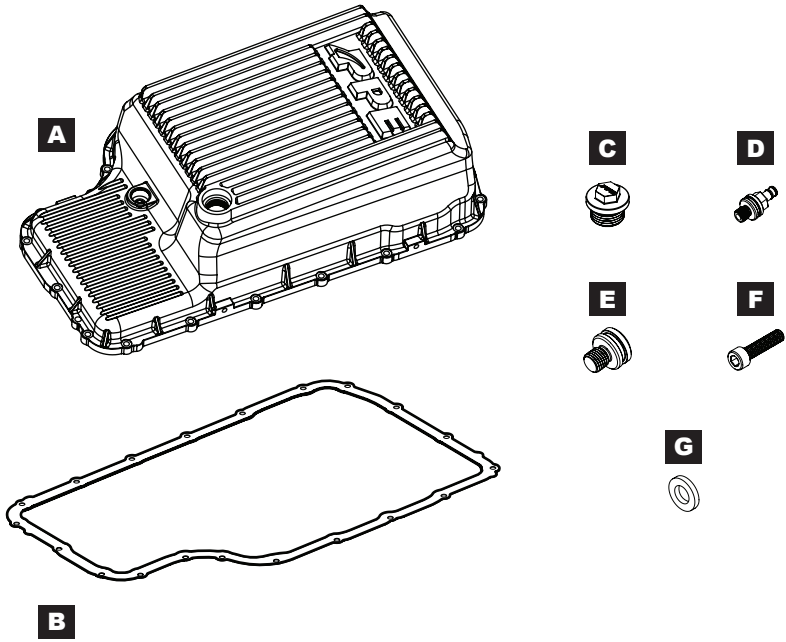

CONTENTS

- A. (1) Deep Transmission Pan
- B. (1) Flat Gasket
- C. (1) Magnetic Drain Plug
- D. (1) Fluid Fill Adapter
- E. (1) Fill Plug
- F. (20) M6 Socket Head Cap Screws
- G. (20) M6 Flat Washers

INSTALLATION

1. Park vehicle on a flat surface and allow transmission fluid to cool down.
2. Remove transmission pan heat shields. **(Fig.1)**



3. Remove transmission cooler mounting bracket to bell housing bolts. **(Fig. 2)**

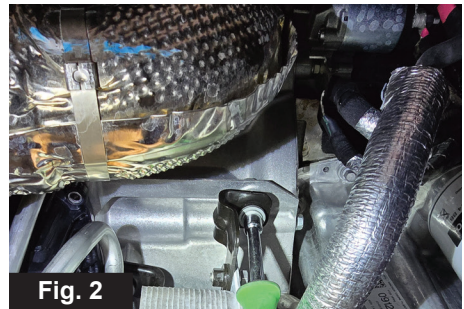

4. Remove the transmission fluid fitting bracket bolt on the side of the transmission case. Disengage transmission line fittings. **(Fig. 3) (Fig. 4)**



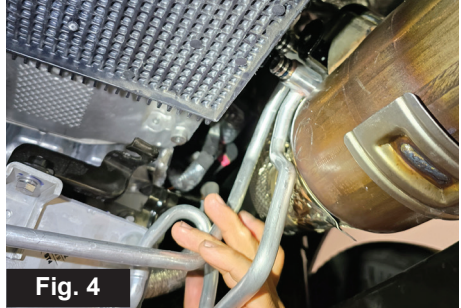

5. Plug off the fittings to avoid spillage. **(Fig. 5)**



6. Remove the stock fill plug underneath the pan to partially drain the transmission fluid. Remove all stock pan mounting bolts and drop stock transmission pan. **(Fig. 6)** Collect and save old fluid if reusing.

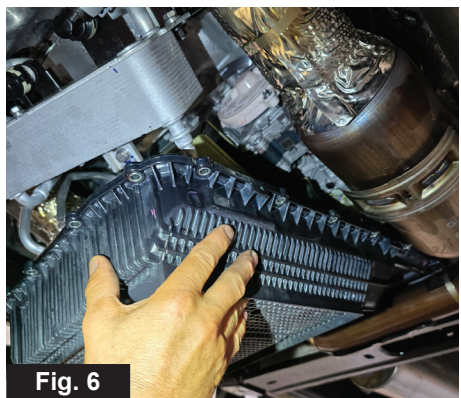

7. A. If reusing stock gasket, remove stock gasket from stock pan and clean thoroughly. Install gasket into the guiding groove of the PPE Pan (A), with the retaining ridges facing downwards, start from the half-moon shapes. **(Fig.7)** Make sure the contour of the gasket closely follows the guiding groove. Press gasket all the way down until it's securely seated. **(Fig. 8)** **(Fig. 9)**

B. If using the supplied flat gasket, place gasket onto the PPE Pan and align all bolt holes. Note that this gasket is not reusable.

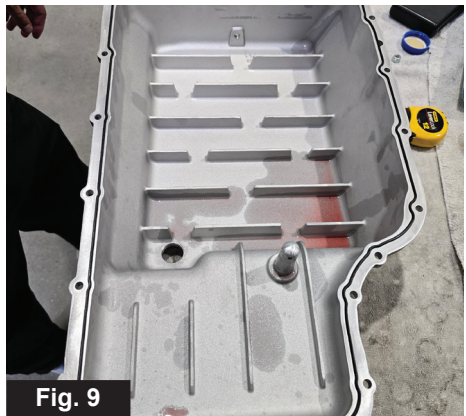
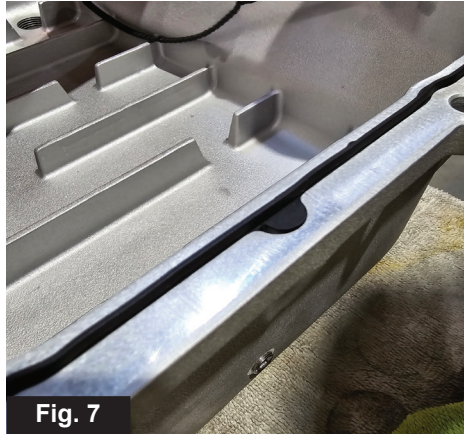

8. Install PPE Pan with supplied bolts (**F**) and washers (**G**). Tighten all bolts finger-tight first, then tighten to 108 lb-in in a crossing pattern. (**Fig. 10**)

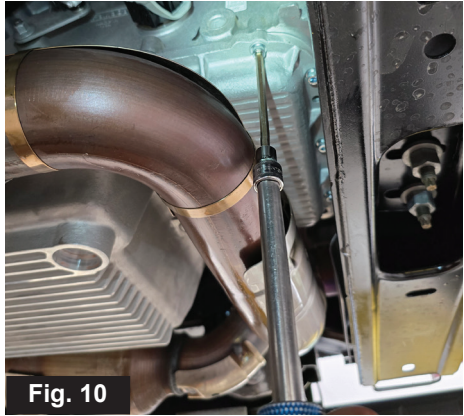

9. Reinstall transmission line fitting and transmission mounting bracket back to their original location. (**Fig. 11**)

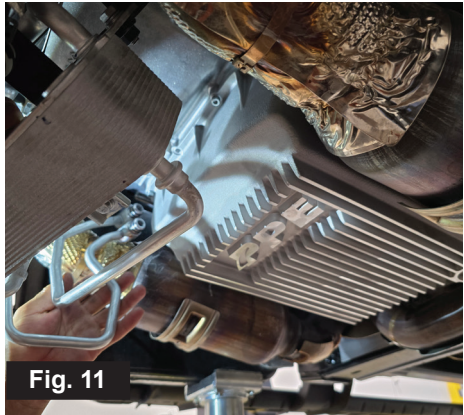

FLUID FILLING

The following steps were performed in our test fitment on a 2024 F-250 7.3L and are presented as a reference only. Follow Ford Service Manual for detailed step by step instructions.

For Reference Only

1. Remove Fill Plug (**E**) from the pan and install Fill Adapter (**D**) to the same location.
2. Utilizing a 3/8" rubber hose and a universal fluid dispenser, add 11 quarts of transmission fluid via the provided Fill Adapter as an initial fill.
3. Note: The initial fill amount will vary if any additional components were removed or serviced (valve body, for instance). In that case, measure the total amount of fluid that was drained during the service, add 5 additional quarts to that as the initial fill.
4. Start the engine and let it idle for approximately 30 seconds.
5. Remove the rubber hose from the Fill Fitting and observe if fluid starts seeping from the Fitting. If not, add fluid in an increment of 0.5 quart until fluid starts to free flow out of the fitting. Allow fluid to flow until it stops flowing continuously.
6. Remove the Fill Adapter and Install the Fill Plug back, torque to 12 lb.-ft.
7. Test drive and shift across all ten gears. Monitor the trans temp gauge, bring the temp up to reach 200°F.
8. Take truck back, with the gear selector in Park and engine running, remove Fill Plug and repeat Step 5 through 6. Beware of the hot fluid.

Installation and fluid filling complete



DISCLAIMER OF LIABILITY

Performance products can increase horsepower above and beyond factory specifications. Additional horsepower creates more stress on the drive-train components, which could result in drive-train failure.

Note regarding emissions-related, non-E.O.-legal products: THESE PRODUCTS ARE LEGAL IN CALIFORNIA ONLY FOR RACING VEHICLES THAT MAY NEVER BE USED, OR REGISTERED OR LICENSED FOR HIGHWAY OR OFF-ROAD USE.

This agreement sets forth the terms and conditions for the use of PPE products. The installation of this product indicates that the Buyer has read and understands this agreement and accepts the terms and conditions. PPE (Pacific Performance Engineering) Inc., its distributors, employees, and dealers (the "Seller") shall not be responsible for the product's proper use and service. The buyer hereby waives all liability claims. The Buyer hereby acknowledges no reliance on the Seller's skill or judgment to select or furnish goods suitable for any particular purpose and that there are no liabilities which extend beyond the description on the face hereof, and the Buyer hereby waives all remedies or liabilities expressed or implied, arising by law or otherwise (including without any obligation of the Seller with respect to fitness, merchantability and consequential damages), or whether or not occasioned by the Seller's negligence. The Seller disclaims any warranty and expressly disclaims any liability for personal injury or damages. The Buyer acknowledges and agrees that the disclaimer of any liability for personal injury is a material term for this agreement and the Buyer agrees to indemnify the Seller and to hold the Seller harmless from any claim related to the item of equipment purchased. Under no circumstances will the Seller be liable for any damages or expenses by reason of use or sale of any such equipment. The Seller assumes no liability regarding the improper installation or misapplication of its products. It is the installer's responsibility to check for proper installation and if in doubt, contact the manufacturer. The Buyer is solely responsible for all warranty issues from the manufacturer.

LIMITATION OF WARRANTY

The Seller gives Limited Warranty as to description, quality, merchantability, and fitness for a particular purpose, productiveness, or any other matter of Seller's product sold herewith. The Seller shall not be responsible for the products proper use and service and the Buyer hereby waives all rights other than those expressly written herein. This warranty shall not be extended, altered or varied except by a written instrument signed by Seller and Buyer. The Warranty on PPE Manifolds and Up-Pipes Kits, OEM-Length Up-Pipes is three (3) years, a limited lifetime warranty on PPE cast aluminum pans and covers, and a limited lifetime warranty on PPE Transmission Coolers and one (1) year limited warranty on all other PPE products from the date of sale to original buyer and limited solely to the parts contained within the products kit. All products that are in question of Warranty must be returned prepaid to the Seller and must be accompanied by a dated proof of purchase receipt. All Warranty claims are subject to approval by Seller. Under no circumstances will the Seller be liable for any labor charged or travel time incurred in diagnosis for defects, removal, or re-installation - of this product or any other contingent expenses. Under no circumstances will the Seller be liable for any damage or expenses incurred by reason of the use or sale of any such equipment. In the event that the buyer does not agree with this agreement: the buyer may promptly return this product, in a new and unused condition in its original packaging, with a dated proof of purchase to the place of purchase within ten (10) days from date of purchase for a full refund. The installation of this product indicates that the buyer has read and understands this agreement and accepts its terms and conditions.





PPEpower.com